

1250 V

SQB 3 DIN 110

 usE180276

Europäische Bauform / European Standard

Verpackungseinheit / Packing unit: 1 Stück / 1 pieces

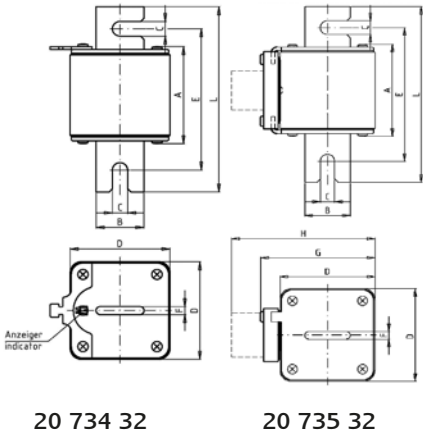

Betriebsklasse / Class aR	IEC 60 269-4 VDE 0636-4 UL 248-13
-------------------------------------	--------------------------------------------------------------

Bemessungs- spannung Rated Voltage	Artikel Article	Größe Size	Länge Length								
			A	B	C	D	E	F	G	H	L
V			mm	mm	mm	mm	mm	mm	mm	mm	
1250	20 734 32	SQB 3	72	35	11	73	106	6	-	-	138
	20 735 32		72	35	11	73	106	6	88	111	138

Bemessungsausschaltvermögen / Rated breaking capacity 100 kA (AC 1300 V)

Bemessungsstrom Rated Current	Artikel Nr. Article No.		Gewicht Weight	Bemessungs- spannung Rated Voltage		Schmelz- integral Pre-Arcing- I ² t-Value	Ausschalt- integral Total I ² t-Value	Leistungs- abgabe Power Loss
	Klappmelder mit Griffflasche Flap indicator with bracket	Mitten-Mikroschalter- Adapter für Meldeschalter Central microswitch adapter for Microswitch 28 001 04 28 011 04		IEC 60 269-4	UL 248-13			
A			kg / 1	V	V	A ² s	A ² s	W
315	20 734 32.315	20 735 32.315	1,26	1250	1300	11.000	60.000	83
350	20 734 32.350	20 735 32.350	1,26	1250	1300	15.000	90.000	85
400	20 734 32.400	20 735 32.400	1,26	1250	1300	22.000	130.000	92
450	20 734 32.450	20 735 32.450	1,26	1250	1300	33.000	190.000	99
500	20 734 32.500	20 735 32.500	1,26	1250	1300	42.000	230.000	110
550	20 734 32.550	20 735 32.550	1,26	1250	1300	56.000	320.000	115
630	20 734 32.630	20 735 32.630	1,26	1250	1300	83.000	480.000	120
700	20 734 32.700	20 735 32.700	1,26	1250	1300	113.000	640.000	131
750	20 734 32.750	20 735 32.750	1,26	1250	1300	169.000	957.000	133
800	20 734 32.800	20 735 32.800	1,26	1250	1300	201.000	1.070.000	135
900	20 734 32.900	20 735 32.900	1,26	1200	1300	236.000	1.300.000	140
1000	20 734 32.1000	20 735 32.1000	1,26	1000	1000	350.000	1.900.000	150
1100	20 734 32.1100	20 735 32.1100	1,26	1000	1000	443.000	2.400.000	174
1250	20 734 32.1250	20 735 32.1250	1,26	900	-	652.000	3.300.000	198
1400	20 734 32.1400	20 735 32.1400	1,26	900	-	852.000	3.900.000	210

Applikationskoeffizienten / Application coefficients (Weiterführende Informationen siehe Seite 13 / for more information see page 13)

a	A2	B1 max.	B2	Cf3
130	0,6	1,25	0,6	0,8

1250 V **SQB 3 DIN 110** c  usE180276

Zeit/Strom-Kennlinie
Time-current characteristics

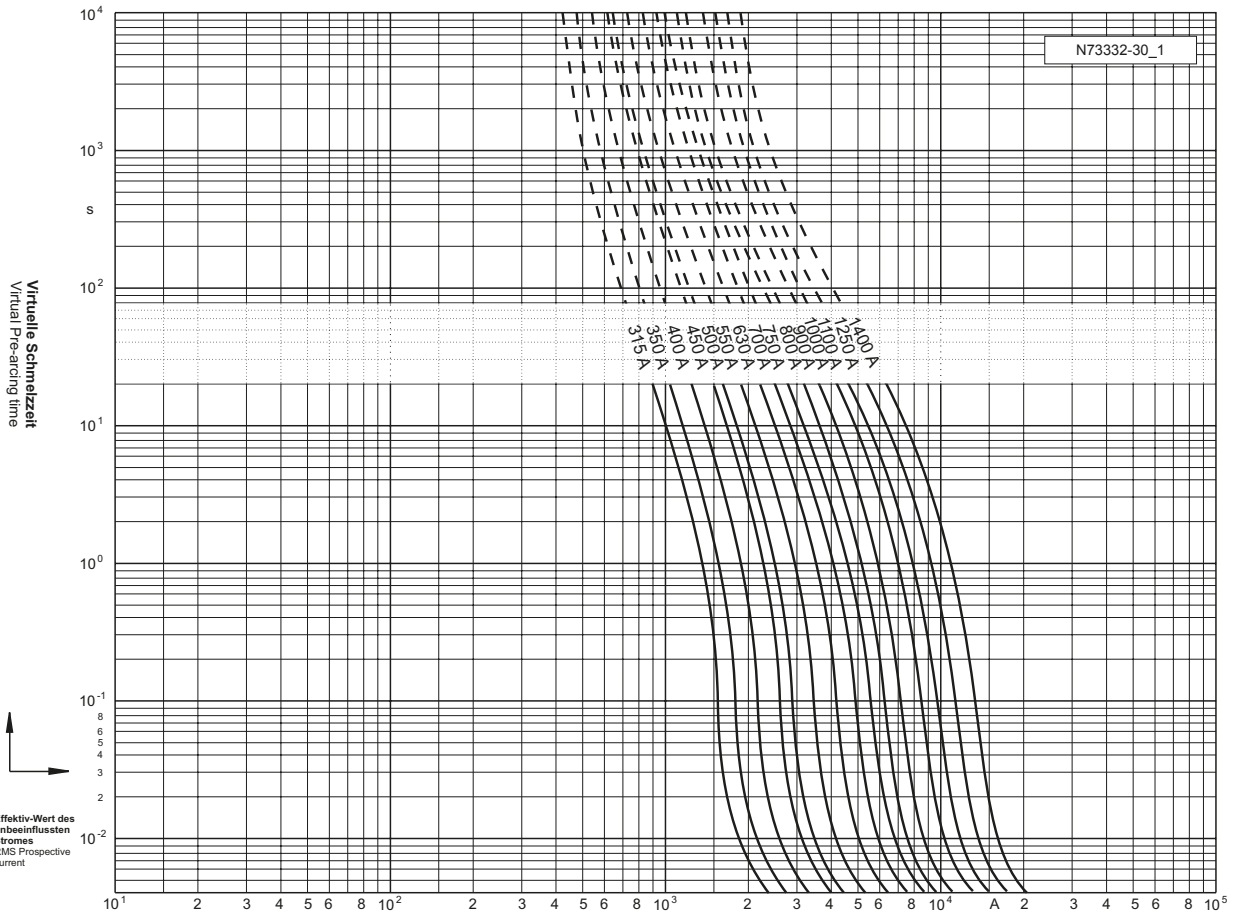

Durchlass-Strom
Cut-off current

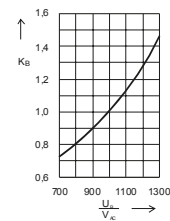
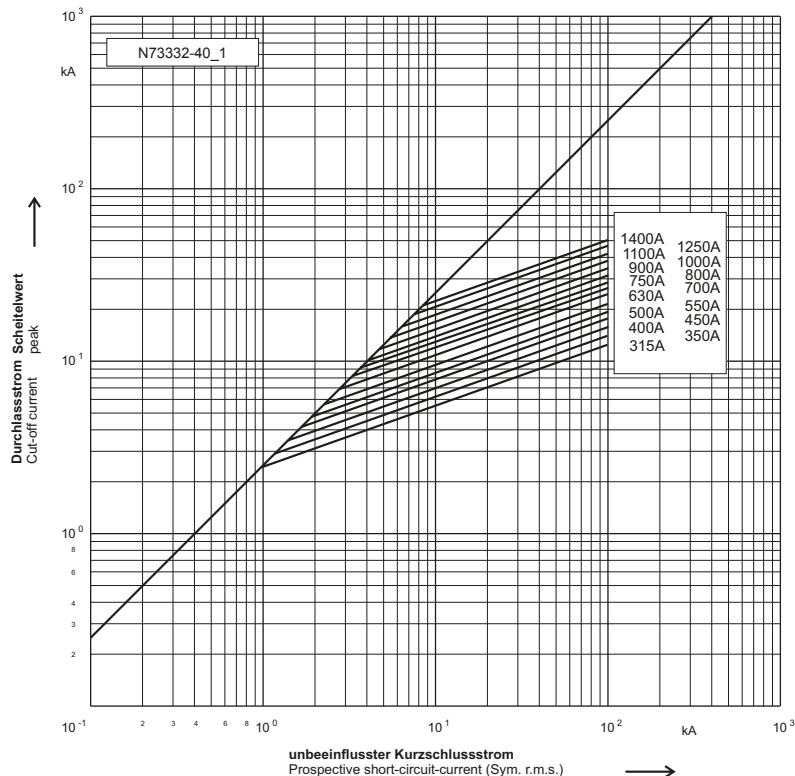

Umrechnungsfaktor für den Ausschalt i²t-Wert
Reduction factor for total i²t-value

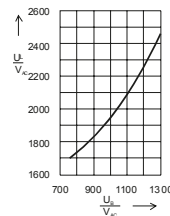

Schaltspannungsdiagramm
Arc Voltage-Diagram

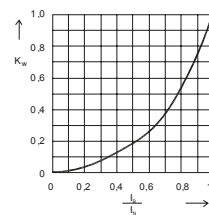

Umrechnungsfaktor der Leistungsabgabe
Reduction factor for power Loss