

## Bases tripolares horizontales cerradas Three pole horizontal design fuse switch disconnectors

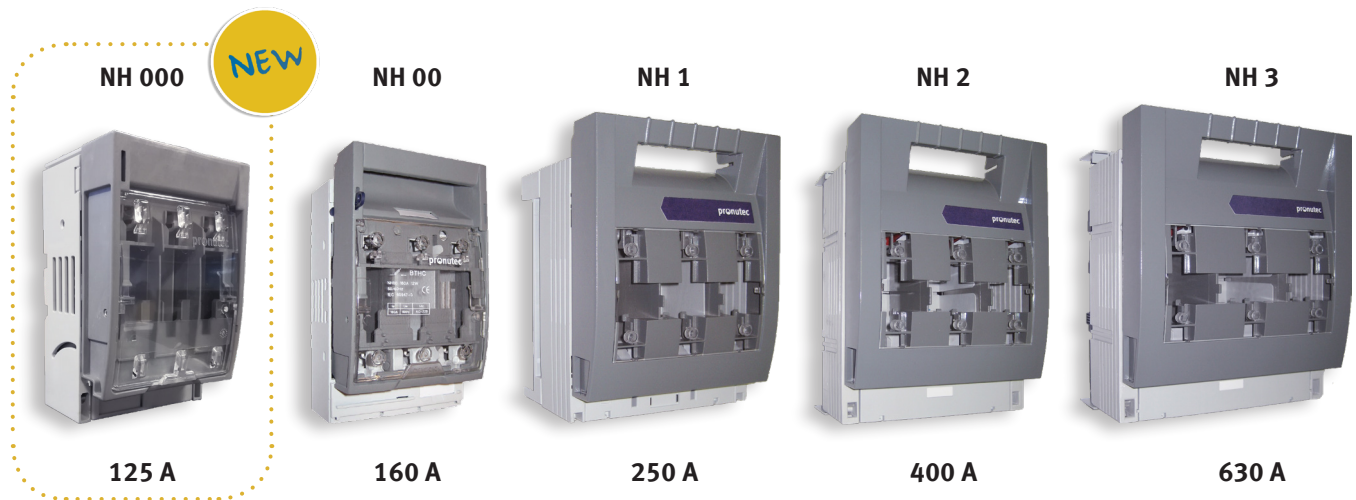

Las Bases tripolares horizontales cerradas desconectables en carga (BTHC), han sido diseñadas atendiendo a los últimos requisitos de seguridad y funcionalidad, y cumplen con los requerimientos especificados en la norma IEC 60947-3.

Pronutec ofrece una amplia gama de BTHC que cubre todas las posibles necesidades tanto de tamaño e intensidad como de tensión asignada o categoría de empleo.

Los tamaños estandarizados en la gama son **NH 000, NH 00, NH 1, NH 2, NH 3** para intensidades hasta 630 A.

Asimismo, la gama contempla todas las variantes en función de las necesidades de instalación, ofreciendo diferentes posibilidades de montaje:

The Three pole horizontal design fuse switch disconnecter (BTHC), has been designed in accordance with the latest safety and operating requirements and it complies with the IEC 60947-3 standard.

The wide range of BTHC configurations offered by Pronutec includes options that attend to any size, current, rated operation voltage and utilization category requirements.

The standardized sizes are **NH 000, NH 00, NH 1, NH 2, NH 3**, for rated operation currents up to 630 A.

This wide range also tends to any installation needs and offers the following assembly possibilities:

**Montaje panel**  
Panel mounting



**Montaje a embarrado de 60 mm**  
60mm Busbar mounting



**Montaje mediante carril DIN**  
DIN rail mounting

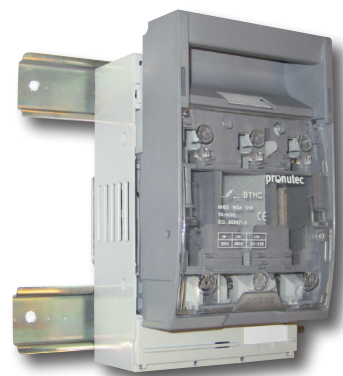

► **GAMA RANGE**

Fusible Fuse-link	Intensidad Current	Tipo de terminal Terminal type	Tipo Type	Sección de cable Cross section	Ref.
NH 000	125 A	Terminal contacto plano Box terminal	Montaje embarrado Busbar mounting	1,5-50 mm <sup>2</sup>	432.21.21.61
		Terminal contacto plano Box terminal	Montaje panel Panel mounting		432.11.01.16.00
NH 00	160 A	Terminal brida Bridge terminal	Montaje embarrado Busbar mounting	6-95 mm <sup>2</sup>	432.22.01.01.00
		M8	Montaje embarrado Busbar mounting		432.22.01.02.00
		Terminal brida Bridge terminal	Montaje panel Panel mounting		432.12.01.01.00
		M8	Montaje panel Panel mounting		432.12.01.02.00
NH 00 <sup>(*)</sup>	160 A	Terminal brida Bridge terminal	Montaje panel Panel mounting		432.42.01.01.00
		M8	Montaje panel Panel mounting		432.42.01.02.00
NH 1	250 A	Terminal contacto plano Box terminal	Montaje embarrado Busbar mounting	35-150 mm <sup>2</sup>	432.23.60.01
		M10	Montaje embarrado Busbar mounting		432.23.60.13
		Terminal contacto plano Box terminal	Montaje panel Panel mounting		432.13.39.31
		M10	Montaje panel Panel mounting		432.13.20.13
NH 2	400 A	M10	Montaje embarrado Busbar mounting	50-240 mm <sup>2</sup>	432.24.60.23
		M10	Montaje panel Panel mounting		432.14.20.23
NH 3	630 A	M12	Montaje embarrado Busbar mounting	150-300 mm <sup>2</sup>	432.25.60.34
		M12	Montaje panel Panel mounting		432.15.20.34

**Gama disponible para montaje en carril DIN.**



Conexiones: Inferior-Superior.

\* Protección extra de la zona de terminales.

**Range available for DIN rail mounting.**

Connections: Bottom-Top.

\* Extra protection in terminals.

Tipo de terminal Terminal type	Sección de cable <sup>(*)</sup> Cross section <sup>(*)</sup>			
	 rm	 re	 sm	 se
Terminal contacto plano Box terminal	1,5-150 mm <sup>2</sup>	1,5-50 mm <sup>2</sup>	-	-
Terminal brida Bridge terminal	10-70 mm <sup>2</sup>	6-70 mm <sup>2</sup>	35-70 mm <sup>2</sup>	50-70 mm <sup>2</sup>
Terminal prisma Prism terminal	10-95 mm <sup>2</sup>	10-95 mm <sup>2</sup>	35-95 mm <sup>2</sup>	50-95 mm <sup>2</sup>
Tornillo M8 M8 screw	Terminal de cable DIN 46235 Cable lugs DIN 46235 max. 95 mm <sup>2</sup>			
Tornillo M10 M10 screw	120-240 mm <sup>2</sup>	120-240 mm <sup>2</sup>	-	-
Tornillo M12 M12 screw	2x185 mm <sup>2</sup>	2x185 mm <sup>2</sup>	-	-

\* Consultar con el Departamento Comercial tipos de sección de cable válidos para cada uno de los terminales.

\* Consult with Commercial Department available cross section types for each terminal.

► **VENTAJAS DE LOS MODELOS NH 000/00**  
**FEATURES FOR NH 000/00 TYPES**

Dispositivo de bloqueo: precintado o cierre con candado de la tapa portafusibles directamente al zócalo.

Sealing device: the sealing/padlocking of the fuse holder made directly on the socle.



Bloqueo tapa (precinto / candado)  
 Fuse holder sealing / padlocking device



Protección para la mano  
 Hand protection

Cómoda extracción de fusibles con guantes  
 External comfortable fuses removal with gloves.

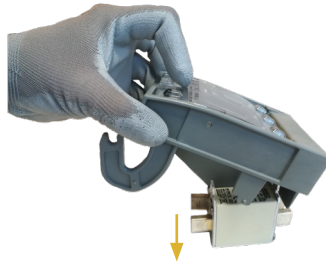

Protección extra en zona de terminales.  
 Extra-protection in terminals area.

► **ACCESORIOS**  
**ACCESSORIES**

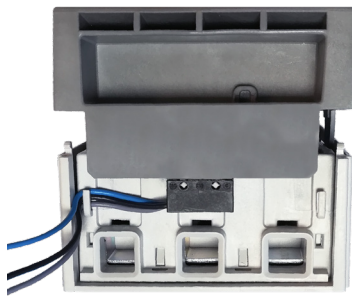

Micro-interruptor  
 Micro-switch



Marco  
 Frame

**Terminales para NH 000**  
**Terminals for NH 000**



Terminal contacto plano  
 Box terminal  
 max. 50 mm<sup>2</sup>

**Terminales para NH 00/1/2/3**  
**Terminals for NH 00/1/2/3**

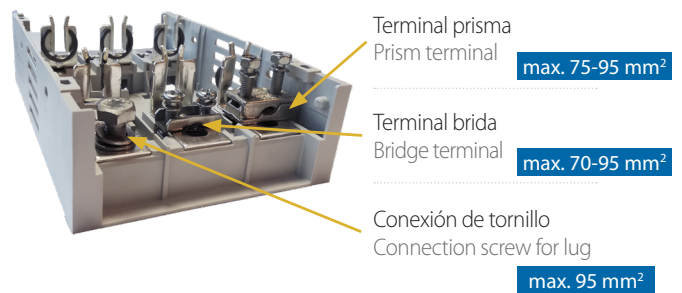

Terminal prisma  
 Prism terminal  
 max. 75-95 mm<sup>2</sup>

Terminal brida  
 Bridge terminal  
 max. 70-95 mm<sup>2</sup>

Conexión de tornillo  
 Connection screw for lug  
 max. 95 mm<sup>2</sup>

## FSC (Control de Fusión de Fusibles) para BTHC FSC (Fuse Supervision Control) for BTHC

- Sistema de monitorización de detección de fusibles fundidos 3 fases: AC 400 V. Compatible con tamaños NH 00/1/2/3.
- Versión electrónica y electromecánica incluida en la tapa portafusibles.
- No se necesita energía adicional.
- Posibilidad de una señal de salida a través de unos contactos auxiliares aislados del circuito principal si se funden uno o más fusibles.
- Tiempo de respuesta corto.
- Monitoring system for detection of blown fuses (3-phases): AC 400 V. Compatible with sizes NH 00/1/2/3.
- Electronic and electromechanical version included in the fuse holder.
- Auxiliary energy not required.
- Possibility of outgoing signal through potential-free auxiliary contacts if one or more fuses get blown.
- Short response time.





### FSC electromecánico para NH 00/1/2/3 Electromechanical FSC for NH 00/1/2/3



### FSC electrónico(\*) para NH 00/1/2/3 Electronic(\*) FSC for NH 00/1/2/3

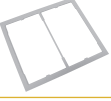

\* Próximamente disponible, consulte con nuestro departamento comercial.  
Coming soon, consult our commercial department.

Artículo Item	Descripción Description	Fusible Fuse-link	Ref.
Accesorios comunes para montaje embarrado y montaje panel Accessories for both busbar mounting and panel mounting			
	Bloqueo de tapa por precinto/candado Fuse holder sealing/padlocking device for fuse switch-disconnector	NH 000/00	432.04.021
		NH 1/2/3	432.08.003
	Micro-interruptor señalización abierto/cerrado Micro-switch for open/close position	NH 000/00	101.34.11
		NH 1/2/3	432.08.005
	Marco simple Single frame	NH 000	432.08.006
		NH 00	432.08.040
		NH 1	432.08.008
		NH 2	432.08.009
	Marco doble Double frame	NH 3	432.08.010
		NH 000	432.08.011
		NH 00	432.08.041
Accesorios exclusivos para montaje panel Exclusive accessories for panel mounting			
	Kit de montaje en carril DIN Distancia entre carriles 125 mm o 150 mm Rapid mounting set for DIN rail Rails centre distance 125 mm or 150 mm		

► PLANOS  
DIMENSIONS

**Montaje panel**  
**Panel mounting**

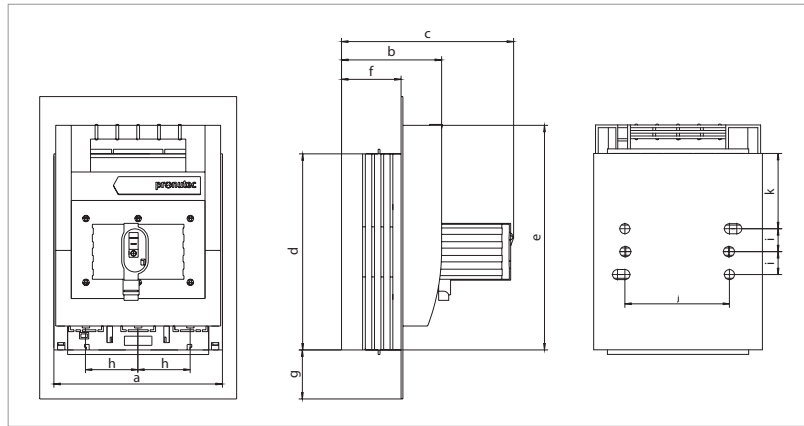

	a	b	c	d	e	f	g	h	i	j	k	Marco Frame
NH 000	89	75	169	140	140	43	35	26	5.25	50	64	130 x 210
NH 00	106	81	175	162	176	45	18	33	12.5	66	62.4	143 x 210
NH 00*	106	81	175	200	176	45	3	33	12.5	66	78.5	143 x 210
NH 1	184	110	206	214	245	65	53	57	25	114	82	215 x 330
NH 2	210	126	223	255	288	80	29	65	25	130	102.5	248 x 330
NH 3	256	139	236	268	312	95	20	81	25	162	109	290 x 330

\* Protección extra en zona de terminales.

\* Extra-protection in terminals area.

**Montaje embarrado**  
**Busbar mounting**

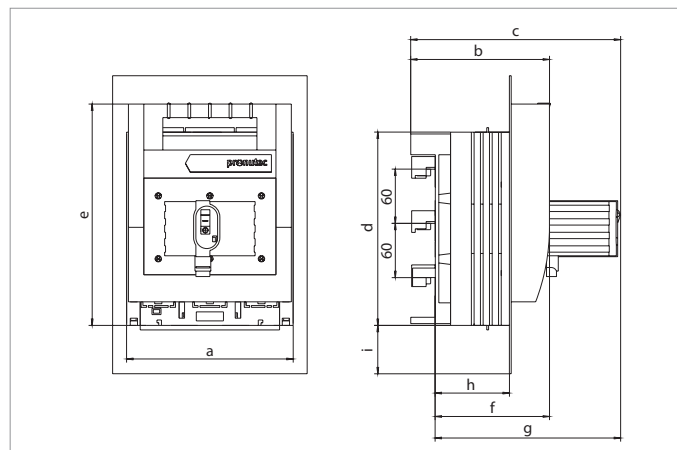

	a	b	c	d	e	f	g	h	i	Marco Frame
NH 000	89	119	208	200	200	90	179	60	7	130 x 210
NH 00	106	126	215	200	200	97	186	62	3	143 x 210
NH 1	184	153	242	210	245	126	215	82	53	215 x 330
NH 2	210	170	259	268	294	142	231	97	29	248 x 330
NH 3	256	187	278	286	317	155	246	112	20	290 x 330

► DATOS TÉCNICOS  
TECHNICAL DATA

IEC/EN 60947-3		432															
		125 A			160 A		250 A			400 A			630 A				
Características eléctricas Electrical characteristics	Tensión asignada de empleo Rated operational voltage	U <sub>e</sub> (V)	AC 500	AC 690	DC 440	AC 500	AC 690	AC 400	AC 690	DC 440	AC 400	AC 690	DC 440	AC 400	AC 690	DC 440	
	Intensidad asignada de empleo Rated operational current	I <sub>e</sub> (A)	125			160		250			400			630			
	Frecuencia asignada Rated frequency	(Hz)	40-60														
	Tensión asignada de aislamiento Rated insulation voltage	U <sub>i</sub> (V)	800			1000		1000			1000			1000			
	Intensidad asignada de cortocircuito condicional Rated conditional short-circuit current	(kA <sub>off</sub> )	50			80		80			50			50			
	Categoría de empleo Utilization category	U <sub>i</sub> (V)	AC-22B	AC-21B	DC-22B (63 A)	AC-22B	AC-22B	AC-22B	AC-21B	DC-20B	AC-23B	AC-22B	DC-22B	AC-23B	AC-22B	DC-22B	
	Tensión asignada de resistencia a los impulsos Rated impulse withstand voltage	U <sub>imp</sub> (kV)	6			8		12			12			12			
	Potencia disipada sin fusibles Total power loss I <sub>th</sub> (without fuse)	P <sub>v</sub> (W)	BM	10,5			20		26			45			60		
PM			5			8		14,1			22			36			
DM																	
Características mecánicas Mechanical characteristics	Peso Weight	BM	1,13			1,03		2,66			5,22			7,56			
		PM	0,57			0,77		1,71			3,62			4,90			
		DM															
Fusible Fuse links	Tamaño Size	-	000			00		1			2			3			
	Potencia máxima disipada del fusible Max. permis. power loss per fuse-link	P <sub>v</sub> (W)	9			12		23			34			48			
Terminales Terminals	Conexión roscada Connection screw	-				M8 95 mm <sup>2</sup>		M10 120 mm <sup>2</sup>			M10 240 mm <sup>2</sup>			M12 2x185 mm <sup>2</sup>			
	Terminal brida Bridge clamp	-				Cu 10-95 mm <sup>2</sup>		Cu 70-150 mm <sup>2</sup>			Cu 120-240 mm <sup>2</sup>			Cu 150-300 mm <sup>2</sup>			
	Terminal de contacto plano Box terminal		Cu 1,5-50mm <sup>2</sup>			-		Cu 35-150 mm <sup>2</sup>			-			-			
Grado de protección Protection degree	Frontal Front operated switchgear fitted	-	IP30														

BM - Montaje embarrado / Busbar mounting  
PM - Montaje panel / Panel mounting  
DM - Montaje en carril DIN / DIN rail mounting