





## Verify The Contents Inside The Package Box

The package should contain the following items plus VIP-1260PT. If any item is missing or damaged, please contact the seller immediately.

VIP-1260PT	Quick Installation Guide
	
Handset	Handset Cord
	
Stand	RJ45 Cable
	

- 1 -

## Step 1. Tilted Stand Installation

Take the stand and hook it on the back of the phone. There are two angles for your selection.

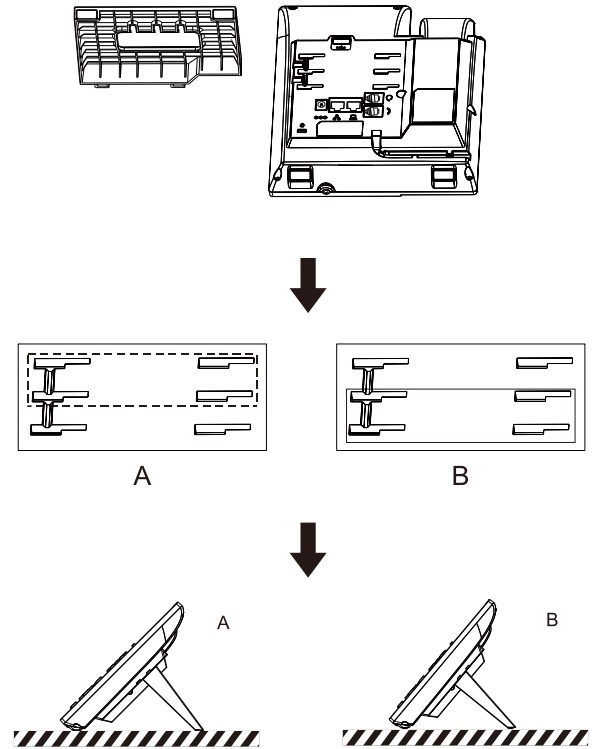

- 2 -

## Step 2. Connecting to the Device

Please connect PoE network, PC and handset to the corresponding ports as described in the diagram below.

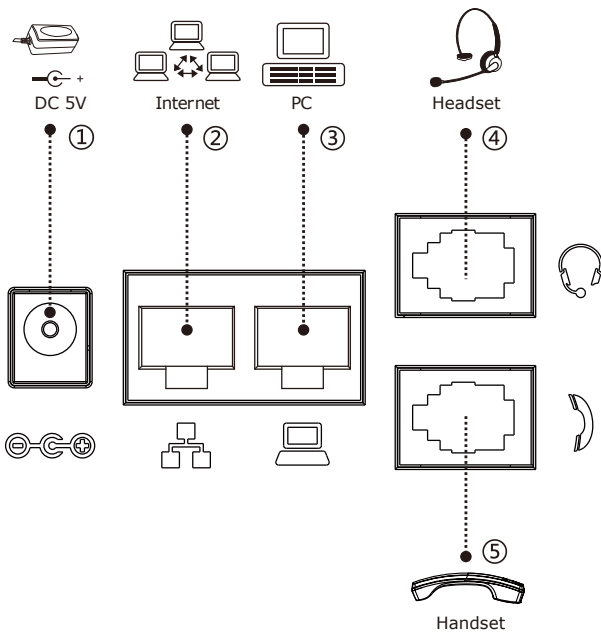

- 3 -

Index	Description
1	<b>Power port:</b> External standard power supply (5V DC, 2A, optional)
2	<b>Internet port:</b> Connect to the Internet (Only Internet port supports PoE. Connect to an IEEE 802.3af/at PSE device such as 802.3af injector / hub or 802.3af/at PoE switch.)
3	<b>PC port:</b> Connect to the computer
4	<b>Headset port:</b> External RJ9 earphone (optional)
5	<b>Handset port:</b> Connect to IP phone handset



Note

1. The VIP-1260PT also supports IEEE 802.3af/at. Be reminded to power either from AC adapter or PoE switch.
2. The AC adapter is not included.

- 4 -

[www.PLANET.com.tw](http://www.PLANET.com.tw)

## High Definition Color PoE Gigabit IP Phone

**VIP-1260PT**



### PLANET Technology Corp.

10F., No. 96, Minquan Rd., Xindian Dist., New Taipei City 231, Taiwan

#### Energy Saving Note of the Device

This power required device does not support Standby mode operation. For energy savings, please remove the DC plug or slide the hardware-based Power Switch to the OFF position to disconnect the device from the power circuit. Without removing the DC plug from or switching off the device, the device will still consume power from the power source. In view of Saving the Energy and reducing the unnecessary power consumption, it is strongly suggested to power off or to remove the DC plug from the device if this device is not intended to be active.



2011-D10610-000

### Step 3. Computer Network Setup

Set your computer's IP address to 192.168.0.x, where x is a number between 2 and 254 (except 1 where is being used for the phone by default). If you don't know how to do this, please ask your network administrator.

### Step 4. Login Prompt

Use Web browser (Internet Explorer 8.0 or above), Chrome, Firefox, or Safari (for Mac) to connect to **192.168.0.1** (Type this address in the address bar of Web browser.)

You'll be prompted to input user name and password: **admin** and **123**



The screenshot shows a web browser window with the PLANET logo at the top. Below the logo, there are three input fields: 'User:' with an empty text box, 'Password:' with an empty text box, and 'Language:' with a dropdown menu showing 'English'. A 'Logon' button is located at the bottom right of the form area.

## Further Configuration

For detailed configuration, please check user's manual which you can download from the website.



<http://www.planet.com.tw/en/support/downloads?&method=keyword&keyword=VIP-1260PT&view=3#list>

If you have any other question, please contact the dealer where you purchased this product or you can contact PLANET directly at the following email address: [support@planet.com.tw](mailto:support@planet.com.tw)